



Deluxe Flush Series

Deluxe Flush Electric Toilets

FEATURES

- Space saving stylish design
- Regular household size seat
- Virtually silent operation for undisturbed sleep
- User selectable choice of "one touch" flush cycles for minimal water usage - a 'Quick Flush' uses less than 1 quart (1 litre)
- Owner selectable choice of leaving bowl wet or dry after use
- Fresh or raw water rinse models
- Non-clogging large bore flush pump macerates waste
- Uses less than 1.0 amp/hour per day
- ISO 8846 MARINE - Ignition Protection
- Crevice free contours for added cleanliness and hygiene
- All plumbing and wiring easily concealed
- Angled or Vertical back vitreous china bowl



Angled





Vertical

The two bowls differ only in the shape of the back of the toilet. The angled back version gives minimal footprint and makes it easy to mount against a sloping surface or in a corner. The vertical back version allows snug fitting against a vertical bulkhead.

* * * * *



MODEL RANGE

Description		Model	Rinse Water Variant	DC Voltage	Fuse / Breaker
	14" Angled Back, Gross Weight 44lbs (20kg)	58060-1012	Fresh	12 Vdc	25 amp
		58060-1024	Fresh	24 Vdc	15 amp
		58260-1012	Raw	12 Vdc	25 amp
		58260-1024	Raw	24 Vdc	15 amp
	14" Vertical Back, Gross Weight 46lbs (21kg)	58080-1012	Fresh	12 Vdc	25 amp
		58080-1024	Fresh	24 Vdc	15 amp
		58280-1012	Raw	12 Vdc	25 amp
		58280-1024	Raw	24 Vdc	15 amp



NEW!
Touch Pad
Controller



Description		Model	Rinse Water Variant	DC Voltage	Fuse / Breaker
	17" Angled Back, Gross Weight 48lb (22kg)	58020-1012	Fresh	12 Vdc	25 amp
		58020-1024	Fresh	24 Vdc	15 amp
		58220-1012	Raw	12 Vdc	25 amp
		58220-1024	Raw	24 Vdc	15 amp
	17" Vertical Back, Gross Weight 57lb (26kg)	58040-1012	Fresh	12 Vdc	25 amp
		58040-1024	Fresh	24 Vdc	15 amp
		58240-1012	Raw	12 Vdc	25 amp
		58240-1024	Raw	24 Vdc	15 amp

RINSE OPTIONS

(1) Fresh Water

(2) Raw Water

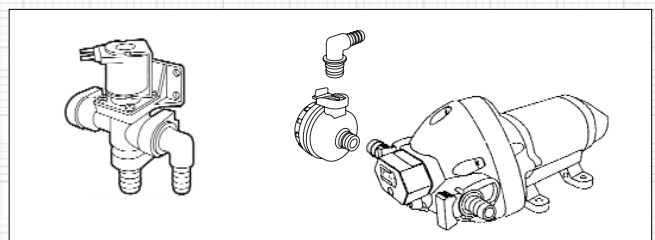

(1) **580X0 Series** are supplied with a combined solenoid valve and siphon breaker assembly for connection to any existing pressurized water system capable of delivering 2.9 US gpm (11 lpm) or more. The siphon breaker ensures there is no backflow from the toilet into the water system.

(2) **582X0 Series** are supplied with a remote mounted self-priming pump to bring in sea, river or lake rinse water. Complete with Pumpgard™ strainer.

* * * * *

TOUCH PAD CONTROLLER



The Deluxe Flush toilet range features a multi-function 'one touch' control pad offering four options - 'Fill', 'Quick Flush', 'Flush' or 'Empty'.

In addition, the owner can set the control at any time so that the bowl is left either 'Dry' or 'Wet' after flushing. The recommended 'Dry' setting minimises total water usage. If water usage is not a concern, the 'Wet' setting automatically adds 1 quart (1 litre) of water after flushing, ready for the next user.

Simultaneously holding down both 'Quick Flush' and 'Flush' buttons for 5 seconds switches between bowl always left 'Dry' and bowl always left 'Wet' modes.

- 'Fill' may be touched when the bowl is 'Dry' to add 1 quart (1 litre) of water before use, if thought necessary.
- 'Quick Flush' first rinses and then empties the bowl after light use. On 'Dry' setting, this uses less than 1 quart (1 litre) of water.
- 'Flush' rinses and empties the bowl twice after heavy use. If the bowl is 'Dry', touching 'Fill' first is recommended. This uses just 2.5 quarts (2.5 litres) of water.
- 'Empty' does exactly what it says without adding any water, whenever desired.

Even when the bowl is apparently 'dry', there is an anti-odour water lock in the pump housing.

* * * * *

APPLICATIONS

You may install JABSCO Deluxe Flush electrically operated marine toilets in both power and sailing craft, either above or below the waterline, for use on sea, river, lake or canal.

	<p>Caution! JABSCO electric toilets are designed specifically for marine use. Consult ITT Industries Jabsco for advice about possible non-marine applications.</p>
--	---

Your installation may discharge the waste either overboard (provided that your national and local regulations allow this), or into a treatment system or into an on-board holding tank (U.S.C.G. Marine Sanitation Devices Type I, II and III).

* * * * *

SPECIFICATIONS

Bowl, seat and cover

- Hygienic white glazed vitreous china bowl for ease of cleaning.
- Luxury wooden seat and cover with tough baked enamel coating.

Flush pump

- Internally mounted, high speed, non-clogging, centrifugal, waste macerating pump driven by powerful 240 watt, 12 or 24 Vdc, permanent magnet motor with ball bearings and robust ceramic seal, discharges up to 6ft (2m) above the base of the toilet.

Either Solenoid Valve

- Jabsco solenoid valve and syphon breaker assembly for connection to any existing pressurised water system capable of delivering 2.9gpm (11 lpm) or more. The syphon breaker ensures that there is no backflow from the toilet into the water system.

Or Rinse pump

- Jabsco, self-priming up to 3m (10ft), dry running, diaphragm water pump driven by 12 or 24 Vdc, permanent magnet, ball bearing motor.

Control Panel

- One Touch 'Press and Release' switch pad, sealed for life, with 10ft (3m) link cable, fitted quick connector, and heat shrink seal.

Control Box

- Sealed for life, with external leads to ship's 12 or 24 Vdc Positive and Negative power supply, to Flush pump and to either Solenoid Valve or Rinse Pump, plus 6 way quick connector input from Control Panel. Reverse polarity protected, computer controlled circuitry with heavy duty mechanical relays for ultra reliability.

Standards

- Complies with ISO8846 MARINE [Ignition protection].



Ports

- Raw Water Rinse pump inlet & outlet, and Toilet Rinse inlet - 3/4" (19mm) hose tails.
- Fresh Water Rinse solenoid valve inlet - choice of 1/2" (13mm) hose tail or 1/2" (13mm) male thread. Outlet - 3/4" (19mm) hose tail.
- Flush pump discharge - 1 1/2" (38mm) hose tail.

Dimensions - inches (mm)

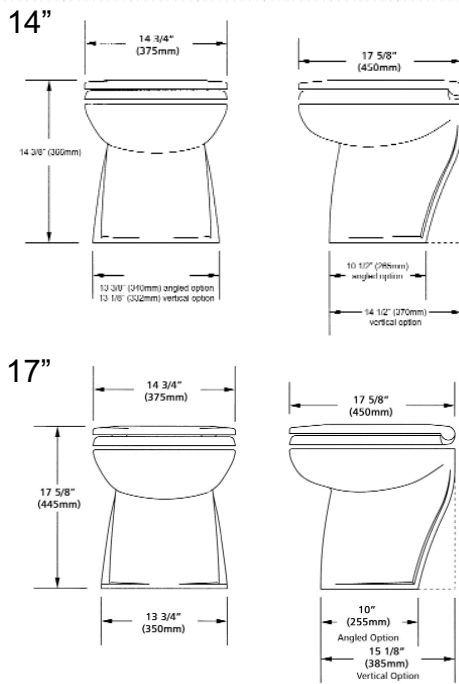

INSTALLATION INSTRUCTIONS

YOUR TOILET is just one part of a system. Correct installation of the whole system is essential if you want the toilet to perform properly, operate reliably and safely, and give satisfactory length of life.

- The seat and lid is delivered boxed and unfitted for its protection.
- Key numbers, e.g. ('Key 31') are references to the exploded view diagram on the back page.

* * *

Location

- Select a location that will give sufficient clearance all round and above the bowl.
- The mounting surface must be flat, rigid and strong enough to support a man's weight and should be at least 2" (50mm) wider and 2" (50mm) deeper than the base of the toilet.
- You will need sufficient clearance below the mounting surface to be able to secure the mounting bolts, and to be able to remove them for maintenance.
- Offer up the seat and lid to the bowl. They should be able to swing up and over, so that they will not fall forward when the craft heels or pitches. When they are swung over they must be supported so that the hinges are not strained. Remove the seat and lid and put them aside until the installation is complete.

* * *

Mounting

YOU WILL need:

- 4 x 1 1/4" (6mm) diameter stainless steel bolts of

length to suit the thickness of the mounting surface.

- 4 stainless steel nuts, preferably self-locking. If you do not use self-locking nuts you will need some nut-locking compound.
- 4 plastic and 4 stainless steel 1 1/4" (6mm) washers
- A tube of white silicone sealant.
- Offer up the toilet in the selected position and, using the holes in the base as a guide, mark the positions for the 4 bolt holes on the mounting surface. Remove the toilet and drill 4 vertical holes of 5/16" (8mm) diameter through the mounting surface.

Now complete all of the rest of the installation before you secure the bowl.

* * *

Through Hull Fittings

YOU MAY need:

- 3/4" 19mm bore seacock for the Rinse pump and, if you are discharging the waste over board, a 1 1/2" 38mm bore seacock for the waste outlet.
- Follow the seacock manufacturer's own instructions concerning materials and methods of installation.
- Ensure the inlet seacock is positioned where it will be below the waterline at all times when the craft is underway, and also ensure that any other outlet seacock is both aft of, and higher than, the inlet seacock.



HAZARD RISK: Through Hull fittings.

FOLLOW THESE INSTRUCTIONS!

If the installation of the toilet results in it being connected to ANY through-hull fitting that may possibly be below the waterline at ANY time, whether when the craft is at rest, underway and heeling or rolling or pitching, you must install the toilet in accordance with these Installation Instructions. If you do not, water may flood in, causing the craft to sink, which may result in loss of life.



HAZARD RISK: Accidental Damage.

USE SEACOCKS!

If the toilet is connected to ANY through-hull fittings and if the toilet or pipework is damaged, water may flood in causing the craft to sink, which may result in loss of life. Therefore, if you are making connections between the toilet and ANY through-hull fittings that may possibly be below the waterline at ANY time, full bore seacocks must be fitted to those hull fittings, to allow them to be shut off.

The seacocks MUST also be positioned where they are easily accessible to all users of the toilet. If, for any reason, it is not possible to do this, then secondary bore marine quality valves MUST be fitted to the hoses where they are easily accessible.



CAUTION! Use lever operated, full bore marine seacocks and valves. The use of screw-down gate valves is not recommended.

Pipework - selection of correct method

YOU MUST select the correct method for the inlet pipework from 2 options and for the outlet pipework from 4 options, according to whether the toilet is above or below the waterline, and to whether it discharges the waste overboard or into an on-board holding tank.

* * *



HAZARD RISK: Bowl Rim Below Waterline.



USE VENTED LOOPS!

If the toilet is connected to ANY through-hull fittings, and if the rim of the bowl falls below the waterline, water may flood in causing the craft to sink, which may result in loss of life.

Therefore, if the rim of the toilet is less than 8" (20cm) above the waterline when the craft is at rest, or if there is ANY possibility that the rim of the bowl may be below the waterline at ANY time, a ventilated anti-syphon loop **MUST** be fitted in any pipework connected to a through-hull fitting, irrespective of whether inlet or outlet.

SPECIAL NOTE 1: The smaller bore inlet pipework is more hazardous than the larger outlet pipework. Unless there is a ventilated anti-syphon loop in the inlet pipework, water will flow into the bowl whenever both the inlet seacock is open and the rim of the bowl is below the actual waterline.

SPECIAL NOTE 2: Making a loop in the hose without fitting a vent may be just as hazardous as no loop at all, because water may syphon over a loop. It is the vent that actually prevents the syphon.

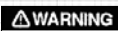

HAZARD RISK: Pipework Becomes Loose.



USE HOSE CLIPS!

If the toilet is connected to ANY through-hull fittings and if the pipework becomes disconnected, either from a through-hull fitting or seacock, or from the toilet or any secondary valve, water may flood in and cause the craft to sink, which may result in loss of life.

Therefore the ends of ALL flexible hoses fitted directly or indirectly between the toilet and ANY through-hull fitting that may possibly be below the waterline at ANY time, **MUST** be secured to the hose tails to which they are connected, using two stainless steel worm-drive hose clips.

Pipework - General instructions for all options

YOU WILL need:

- *Spiral reinforced smooth bore flexible hoses for both the 3/4" 19mm inlet and the 1 1/2" (38mm) outlet pipework.*
- *Two stainless steel worm-drive hose clips for*

every hose tail connection.

- Secure the hose runs so that the hoses cannot move and chafe, and so that they do not exert any leverage on the hose tail fittings to which they are connected, as this may cause adjacent joints to leak.
- Avoid sharp bends in the hoses as this may cause them to become kinked.
- Keep all pipework runs as straight and as short as possible, avoiding rising and falling over obstructions which creates airlocks.
- If it is difficult to fit the hose onto the hose tails of the toilet or seacocks, lubricate it with water, or soften the hose by dipping the end in hot water.



CAUTION: Do not apply flame to the hose. Do not apply flame or heat to the plastic hose tails on the toilet, rinse pump or solenoid valve. Do not use oils, greases or synthetic lubricants. Do not apply sealing compounds to any hose connections. Do not over tighten hose clips. Any of these actions may result in cracking or breakage of the plastic parts.

- Secure the ends of all hoses to the hose tails with two stainless steel worm-drive hose clips, ensuring that all inlet connections are airtight and that all the outlet connections are water tight.

* * *

Fresh Water Rinse Pipework

YOU WILL need:

- *A 'T' piece that fits your boat's pressurised water system pipework.*



CAUTION: Turn off power to the water pressure system pump, and open cold water taps to de-pressurise the system.

- Install a 'T' fitting in the pressurised cold water pipework near to the toilet to provide a 1/2" (13mm) feed to the Solenoid Valve.



CAUTION: If you ever connect your water system to unregulated USA City Water supplies, you **MUST** fit or use a Pressure Regulator to prevent risk of flooding.

- Mount the Solenoid Valve and Syphon Valve assembly (key 31) in a dry position, on a vertical surface, with the outlet port facing **DOWN**, as close to the Rinse Intake Elbow (key 3) as possible **AND** at least 8" (20cm) **ABOVE** the Rinse Intake Elbow.
- Install suitable pipework between the 'T' fitting and the 1/2" (13mm) inlet port on the Solenoid Valve.
- Run 3/4" (19mm) hose by the most direct route from the 3/4" (19mm) outlet port on the Solenoid Valve to the Rinse Intake Elbow.

* * *

Raw Water Rinse Pipework - 2 options

- Install the Raw Water Rinse pump (key 32) in a dry position close to the toilet where it will not be more than 6ft (2m) above the heeled waterline at any time.

- Fit the Pumpguard™ (key 33) supplied to the inlet of the Rinse pump.
- For more detail refer to the separate Data Sheet supplied with the Rinse pump.

- Arrange the outlet hose to form a loop which is at least 8" (20cm) above the highest possible level that the top of the tank may reach, and fit the Vented Loop at that highest point.

Option 1: Toilet below the heeled waterline

YOU MUST fit a ¾" (19mm) Vented Loop fitting, Jabsco part number 29015-0000.

- Run ¾" (19mm) hose by the most direct route from the inlet seacock to the inlet of the Pumpguard™ fitted to the Rinse pump.



CAUTION: Do not position the ventilated anti-syphon loop between the inlet seacock and the rinse pump, because it may prevent the rinse pump from priming.

- Arrange a length of ¾" (19mm) hose between the Rinse pump outlet and the Rinse Intake Elbow (key 3), to form an anti-syphon loop whose highest point is at least 20cm (8") above the highest possible waterline, and fit the ¾" (19mm) Vented Loop at the highest point.

Option 4: Toilet discharging into holding tank, AND non-return valve always above the top of holding tank.

- Run the outlet hose by the most direct route from the non-return valve assembly (key 24) down to the holding tank inlet.

* * *

Controls and Electrics

YOU MUST:

- Connect the Control Box (key 26) either directly to the battery or to a primary distribution board with sufficient spare amperage capacity.
- Keep the total length of both the positive and negative wires to a minimum, selecting your wire size from the Electrical Specifications table below.



CAUTION: Inadequate wire size will result in voltage drop, and will reduce performance.

- Make all joints with appropriately rated marine grade terminal blocks and crimp connectors.
- Use marine grade multi-strand copper wire.
- Support all wires approximately every 18" (45cm) with plastic cable clips.

Option 2: Toilet always above the heeled waterline

- Run ¾" (19mm) hose by the most direct route from the inlet seacock to the inlet of the Pumpguard™ fitted to the Rinse pump.
- Run ¾" (19mm) hose by the most direct route from the outlet of the Rinse pump to the Rinse Intake Elbow.

* * *

YOU MUST FIT the correct size of fuseholder or circuit breaker, selected from the Electrical Specifications table. If you connect the Control Box directly to the battery, fit your fuseholder or circuit breaker within 7" (17cm) of the battery.



CAUTION: Remove fuse, or turn circuit breaker off, whilst installing Controls and Electrics.

Discharge Pipework - 4 options

Option 1: Toilet below the waterline and discharging overboard.

YOU MUST fit a 1½" (38mm) Vented Loop fitting, Jabsco part number 29015-0010.

- Run 1½" (38mm) outlet hose from the non-return valve assembly (key 24) to form a loop which is at least 8" (20cm) above the highest possible waterline, and fit the 1½" (38mm) Vented Loop at the highest point.

- Fix the Control Box (key 26) in a dry but accessible position close to the Flush pump.
- Select a position for the Control Panel (key 26) that is convenient for both standing and seated users, and which allows you to run the 10ft (3m) control cable out of sight to the Control Box.

Option 2: Toilet always above the heeled waterline and discharging overboard.

- Run 1½" (38mm) outlet hose from the non-return valve assembly (key 24) down to the outlet seacock by the most direct route.

- To use the Jabsco Fascia Panel provided, (Key 29) drill a 5/8" (16mm) hole for the 6 way control cable connector. Screw the control panel (key 28) onto selected location with suitable counter sunk head screws. Clip on fascia panel (key 29)

Option 3: Toilet discharging into holding tank AND top of holding tank above non-return valve at any time.

YOU MUST FIT a 1½" (38mm) Vented Loop fitting, Jabsco part number 29015-0010.

- If there is ANY possibility that the discharge non-return valve assembly (key 24) may be below the top of the tank at ANY time, a ventilated anti-syphon loop must be fitted in the outlet pipework to ensure that the contents of the tank do not syphon out through the bowl.

- To use Gewiss fascia panels remove the four screws tabs (see picture below). Cut a rectangular hole 53mm x 92mm. Fix panel to selected location with four counter sunk head screws. Clip on Gewiss fascia panel
- To use Vimar fascia panels remove the four screw tabs (see picture below) Cut a

rectangular hole 53mm x 92mm. Place adaptor (key 30) onto panel (key 28) and screw into place with four counter sunk head screw. Clip on Vimar panel onto adaptor.

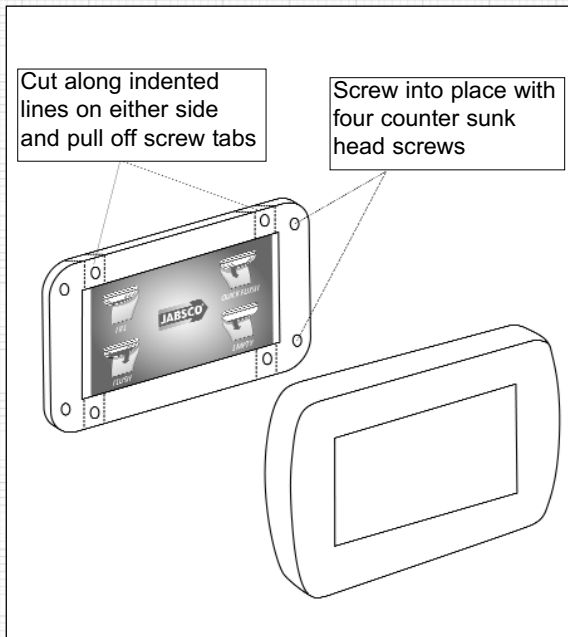

- Slide the Heat Shrink Sleeve (key 27) over the control cable. Plug in the 6 way control cable to the Control Box, and carefully use a hot air gun or hairdryer to seal the Heat Shrink Sleeve over the 6 way connector.
- Note that the Control Box has 4 other leads - Red and Black, Orange and Blue.

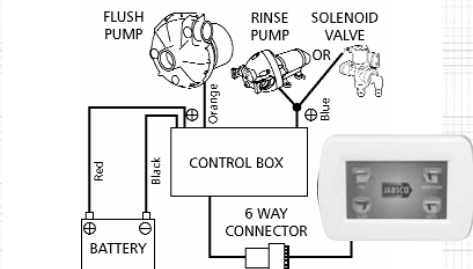

- Connect your boat's Positive (+) feed to the Red (+) input lead of the Control Box, and your boat's Negative (-) return to the Black (-) output lead of the Control Box.
- Connect the Orange (+) output lead of the Control Box to the Red (+) input lead of the Flush pump motor (key 21).
- **Either** connect the Blue (+) output lead of the Control Box to any terminal of the Solenoid Valve (key 31) **or** to the Red (+) input lead of the Raw Water Rinse pump (key 32).
- **Either** connect the remaining terminal of the Solenoid Valve **or** the Black (-) output lead of the Rinse pump to your boat's Negative (-) return.

ELECTRICAL SPECIFICATIONS							
Voltage	Amp Draw	Fuse/Breaker	Wire size mm ² (AWG) per metre (foot) of length*				
			0-4m (0-13ft)	4-6m (13-20ft)	6-12m (20-40ft)	12-18m (40-60ft)	
12 Vdc	20	25 amp	4 mm ² (#10)	6 mm ² (#8)	8 mm ² (#6)	19mm ² (#4)	
24 Vdc	10	15 amp	2.5mm ² (#16)	4 mm ² (#14)	6 mm ² (#10)	8mm ² (#10)	

* Wire length is the total distance from the battery to the Flush pump and back to the battery

Securing the bowl and fitting the seat and lid

- Apply a bead of white silicone sealant to the base of the toilet.
- Bolt down the toilet, using plastic washers next to the china, with stainless steel washers between the plastic washers and the bolt heads. Tighten the fastenings securely. If you are not using self-locking nuts, use nut-locking compound.
- Fit the seat and lid using the adjustable fastenings supplied with it.

Testing

- Ensure that the battery is fully charged, and that the circuits are live.
- Open both seacocks.
- Refer to the next section - OPERATING INSTRUCTIONS.
- To prime the Solenoid Valve or Rinse pump on first installation, operate the 'Quick Flush' function several times until water flows into the toilet bowl. Thereafter they are automatically switched by the Control Panel.

Safety

Ensure that this INSTRUCTION MANUAL reaches the owner, skipper or operator of the craft as it contains essential safety information.

ON COMPLETION - CLOSE BOTH SEACOCKS

* * * * *

OPERATING INSTRUCTIONS

The toilet is one of the most used pieces of equipment on your boat. Correct operation of the toilet is essential for the safety and comfort of your crew and craft.

- Open inlet and outlet seacock (and secondary valves if fitted)
- Use Touch Pad Controller as described on Page 2.
- Use good quality hard or soft household toilet paper, but do not use more than necessary.
- Do not put anything in the toilet unless you have eaten it first, except toilet paper.



HAZARD RISK: Accidental Damage. SHUT SEACOCKS!

If the toilet is connected to ANY through-hull fittings that are below the waterline at any time, and if the toilet or pipework is damaged, water may flood in, causing the craft to sink, which may result in loss of life.

Therefore after every usage, both seacocks (or secondary valves) MUST be shut.

Whenever your craft is unattended, even if for only a short period of time, both seacocks (even if secondary valves are fitted) **MUST** be shut.

- Ensure that ALL users understand how to operate the toilet systems correctly and safely, including seacocks and secondary valves.
- Take special care to instruct children, the elderly and visitors.

* * *

Cleaning

- To clean the bowl, use any liquid or cream ceramic cleaner.



CAUTION: Do NOT use aggressive chemical agents such as Acetone or Bleach because the plastic parts may crack and the enamel coating on the seat and lid may blister.

- To clean the rest of the toilet, including the seat and lid, use a non-abrasive liquid cleaner. Polish with a dry cloth only.



CAUTION: Do not use abrasive pads on any part of the toilet and do not use cream cleaners except for the bowl.

- To disinfect the toilet, use a liquid disinfectant diluted in accordance with the manufacturers instructions. You may apply it to all parts of the toilet using a sponge or soft brush as necessary.



CAUTION: Do not use thick liquid toilet cleansers or neat bleach. They may damage the valves, gaskets, seals and the enamel coating of the seat and lid.

SERVICING INSTRUCTIONS

Jabsco Deluxe Flush electric toilets do not normally require maintenance during the season, provided that they are winterised in the autumn.

- Regularly check all fastenings for tightness and leaks.

WARNING

HAZARD RISK: Leaks.



REPAIR LEAKS IMMEDIATELY!

If the toilet is connected to ANY through-hull fittings and, if the toilet or the pipework develops a minor leak, it can suddenly become a major leak that allows water to flood in, causing the craft to sink, which may result in loss of life. Therefore, if ANY leak develops you must repair it immediately.

Control Panel and Control Box

- These 'sealed for life' units are maintenance free.

Solenoid Valve

- The Solenoid Valve is maintenance free.

Rinse pump

- Please refer to the Data Sheet provided for the 31331-Series Rinse pump.

Ceramic shaft seal

- In the unlikely event that water begins to drip from the shaft of the Flush pump motor (key 18), the ceramic seal is worn and must be replaced.

Electrical connections

- Carefully inspect all electrical connections, even if they are protected. Remove any corrosion on the terminals or in the cables, and remake any loose or weak connections, because these cause voltage drop when under load, which directly reduces both Rinse and Flush pump performance. Protect all electrical connections against moisture.

Servicing & Winterisation - preparation

Jabsco Deluxe Flush electric toilets are designed to be user serviceable and no special skills are required.

- Flush the toilet in accordance with the OPERATING INSTRUCTIONS and ensure that all waste has left the discharge pipework and that the bowl is empty.
- CLOSE BOTH SEACOCKS (even if secondary valves are fitted)
- SWITCH OFF POWER OR REMOVE FUSE.
- Be ready to mop up any water that may come out of the system.

Servicing - Winterisation

Drain the complete system, both as protection against frost damage and to discourage the growth in the pipework of bacteria that cause unpleasant smells.

- Loosen hose clips and disconnect the hose ends from both the seacock hose tails. Ensure that all water is drained from the toilet system.



CAUTION: The use of anti-freeze is NOT RECOMMENDED, as it is impossible to ensure that it penetrates the complete toilet system. If, for any reason, anti-freeze is used it MUST be glycol based.

WARNING



HAZARD RISK: Seacocks opened by mistake.

ATTACH WARNING NOTICE!

If you leave the toilet disassembled and, if the seacocks are opened when the craft is afloat, water will flood in and may cause the craft to sink, which may result in the loss of life. Therefore, you MUST attach a warning notice to the seacocks and, if possible wire the seacocks shut.

If you are not leaving the toilet disassembled:

- Reconnect all hose ends and secure them with their hose clips.
- Replace the non-return valve assembly.
- Fasten down the seat and lid to prevent use and attach a warning notice.

Servicing - Flush pump

YOU WILL need a phillips screwdriver, flatblade screwdriver, spanner (7mm), 10mm socket (1/4" drive) and a Service kit 58100-2000 - refer to the PARTS LIST for details.

Remove complete pump assembly

- Unfasten and separate waste valve clamp from discharge elbow. Non-return valve (key 24). Keep its fastenings and its joker (key 25) valve, and inspect it. Replace the joker valve if it is damaged or age hardened.
- Remove the hose clip (key 10) where the inlet hose (key 9) is fastened to the bowl outlet.
- Cut the support strap (key 5) that fastens the motor to the support block (key 6).
- Cut the support strap (key 4) that holds the hose
- Remove the complete pump and hoses assembly from the bowl. Disconnect the Flush pump positive and negative motor leads.

Check pump chamber

- Undo the seven screws (key 11 & 12) and nuts (key 20) that fasten the upper pump body (key 14) to the lower pump body (key 20)
- Separate the 2 pump bodies. Remove the joint ring (key 15), and inspect it. Replace the joint ring if it is damaged or age hardened.
- Thoroughly clean and de-scale all parts.

Remove shaft seal (only if leaking)

- Hold the impeller and undo the nut holding it onto the shaft (nb. this is a left handed thread). The nut will need to be replaced. Remove impeller from shaft.
- Separate lower pump body from motor.
- Using a blunt instrument, carefully push out the ceramic seal assembly (key 19) from the lower pump body (key 20).

Fit new shaft seal

YOU MUST:

- *Have perfectly clean and dry fingers when you handle the ceramic seal, or wear surgical gloves.*



CAUTION: Do NOT allow anything at all to touch or fall onto the mating faces of the new ceramic seal!

- Take the stationary half of the new seal (white ceramic face in rubber cup) and, with rubber cup at the bottom, press it into the seal housing in the lower pump body (Key 20) using your clean, dry fingers only, leaving white ceramic face exposed.
- Carefully slide the rotating half of the ceramic seal (black carbon face) down the motor shaft to cover the white ceramic face.
- Replace impeller on motor shaft. Fit washer and left hand nut.

Re-assemble pump

- Place joint ring (key 15) in position.
- Re-fasten the upper pump body (key 14) to the lower pump body (key 20), using the 7 screws (key 11 & 12) and nuts (key 13).

Refit pump assembly

- Reconnect the Flush pump positive and negative motor leads. Offer up the complete pump and hoses assembly to the bowl and to the bowl outlet.
- Re-fasten the motor to the support block (key 6), using a new support strap (key 5).
- Re-fasten the inlet hose (key 9) to the bowl outlet, with the hose clip (Key 10), using a new support strap (key 4).
- Re-assemble non-return valve assembly.

Hoses

- Examine all hoses throughout their length for chafe, kinks and splits under hose clips. Check all hose clips for corrosion and replace worn or damaged parts.



CAUTION: Do not apply flame to the hose. Do not apply flame or heat to the plastic hose tails on the toilet, rinse pump or solenoid valve. Do not use oils, greases or synthetic lubricants. Do not apply sealing compounds to any hose connections. Do not over tighten hose clips. Any of these actions may result in cracking or breakage of the plastic parts.

- Reconnect all loose hose ends and secure them with their hose clips.

Servicing - Testing

- Open inlet and outlet seacocks (and secondary valves if fitted).
- Switch on power of replace fuse.
- Use Touch Pad Controller as described on page 2, to check all functions, and then inspect for leaks.

ON COMPLETION - CLOSE BOTH SEACOCKS!

* * * * *

SPARE PARTS

Service Kits Available		
Kit	Part no.	Description
A	58100-2000	Major Service Kit
B	58103-1012	Pump Assembly, 12v
	58103-1024	Pump Assembly, 24v
C	58029-1000	Control Kit

Key	Description	Qty per Toilet	Part no.	Qty per Service Kit		
				A	B	C
1	Seat & Lid, Set	1	58104-1000			
2	Hinge Kit, Pair	1	58105-1000			
3	Rinse Intake Seal & Elbow	1	58107-1000			
4	Support Strap, Discharge Hose	1	See Kits	1	1	
5	Support Strap, Motor	1	See Kits	1	1	
6	Support Block, Motor	1	See Kits	1	1	
7	14" Bowl, Angled Back	1	58048-1000			
	14" Bowl, Vertical Back	1	58068-1000			
	17" Bowl, Angled Back	1	58028-1000			
	17" Bowl Vertical Back	1	58038-1000			
8	Hose Clip, Large	1	See Kits	1	1	
9	Inlet Hose, Flush Pump	1	See Kits	1	1	
10	Hose Clip, Medium	1	See Kits	1	1	
11	Screw, Long	4	See Kits	1	4	
12	Screw, Short	3	See Kits	1	3	

Key	Description	Qty per Toilet	Part no.	Qty per Service Kit		
				A	B	C
13	Nut	7	See Kits	2	7	
14	Pump Body, Upper	1	See Kits	1		
15	Ring Seal	1	See Kits	1	1	
16	Nut	1	See Kits	1	1	
17	Washer	1	See Kits	1	1	
18	Impeller	1	See Kits		1	
19	Ceramic Seal	1	See Kits	1	1	
20	Pump Body, Lower	1	See Kits		1	
21	Motor 12v	1	See Kits		1	
	Motor 24v	1	See Kits		1	
22	Outlet Hose, Pump	1	See Kits	1	1	
23	Clip, Small	2	See Kits	2	2	
24	Non - Return Valve Assembly	1	58109-1000			
25	Joker Valve	1	29092-1000			
26	Control box, electronics	1	See Kits			1
27	Heat Shrink Sleeve, Control Cable	1	See Kits			1
28	Panel	1	See Kits			1
29	Jabsco White Fascia Panel	1	See Kits			1
30	Adaptor Plate	1	See Kits			1
31	Solenoid Valve, 12v	1	37038-1012			
	Solenoid Valve, 24v	1	37038-1024			
32	Rinse Pump, 12v	1	31331-0092			
	Rinse Pump, 24v	1	31331-0094			
33	Pump Guard	1	46400-9500			



EXPLODED VIEW

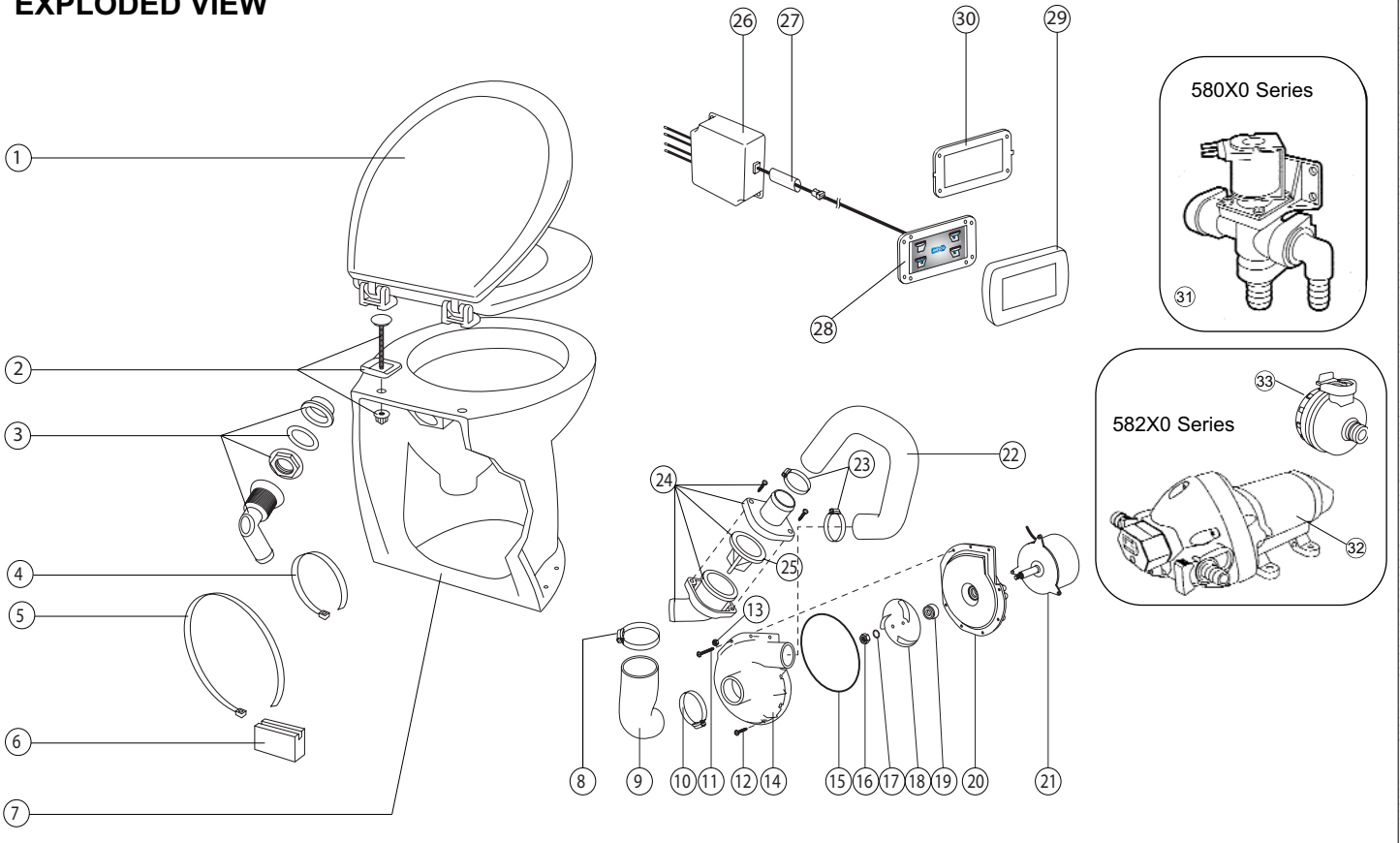

TROUBLE SHOOTING

Bowl fills when not in use

- Shut seacocks
- Fit Vented Loops

Waste water re-appears in bowl

- Check non-return valve assembly (key 24)

Bowl does not empty

- Open Outlet Seacock
- Check non-return valve assembly (key 24), Discharge Hose or Outlet Seacock for blockage.
- Remove pump and check for blockage

Water does not come in

- Open Inlet seacock
- Check Inlet hose connections are airtight
- Check electrical connections to Solenoid Valve or Rinse pump

GB



ITT

Engineered for life

ITT Industires, Bingley Road, Hoddesdon, Hertfordshire, EN11 0BU
Tel: +44 (0) 1992 450 145 Fax: + 44 (0) 1992 467 132

UK

Cleghorn Waring/ITT Corporation, UK Sales
Icknield Way, Letchworth Garden City, Hertfordshire, SG6 1EZ
Tel: +44 (0) 1462 480 380 Fax: +44 (0) 1462 482 422

UK

ITT Corporation, 1 Kondelin Road, Cape Ann Industrial Park, Gloucester, MA 01930
Tel: +1 978 281 0440 Fax + 1 978 283 2619

USA

Jabsco GmbH, Oststraße 28, 22844 Norderstedt
Tel: +49 (0) 40 53 53 73 0 Fax: +49 (0) 49 53 53 73 11

GERMANY

Jabsco Marine Italia, Via Tommaseo 6, 20059 Vimercate, Milano
Tel: +39 039 685 2323 Fax +39 039 666 307

ITALY

NHK Jabsco Co. Ltd, 3-21-10 Shin-Yokohama, Kohoku-ku, Yokohama 222
Tel: +82 (0) 45 475 8906 Fax: +81 (0) 45 477 1162

JAPAN